

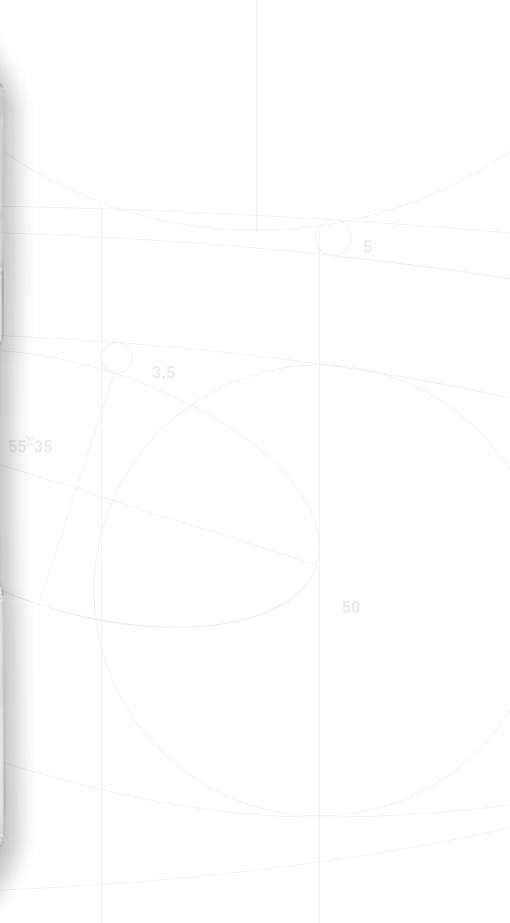

DIMENSION ONE SPAS®

100

••••• @HOME COLLECTION



Owner's Guide

# Spa Information

My Spa: \_\_\_\_\_

Model Name: \_\_\_\_\_

Serial Number: \_\_\_\_\_

Date Installed: \_\_\_\_\_

Dealer's Name: \_\_\_\_\_

# Table of Contents

<b>1.0</b>	<b>Important Hot tub Owner Information .....</b>	<b>1</b>
<b>2.0</b>	<b>FCC Notice.....</b>	<b>1</b>
<b>3.0</b>	<b>Important Safety Instructions for all Hot tub Owners.....</b>	<b>2</b>
3.1	Entrapment Risk .....	7
3.2	Hyperthermia .....	8
3.3	Warning Signs .....	9
3.4	Important safety instructions.....	9
<b>4.0</b>	<b>Choosing a Location.....</b>	<b>10</b>
4.1	Outdoor Location .....	11
4.2	Indoor Location .....	11
<b>5.0</b>	<b>General Electrical Safety Instructions .....</b>	<b>12</b>
<b>6.0</b>	<b>Electrical Installation Instructions .....</b>	<b>13</b>
<b>7.0</b>	<b>Power Requirements .....</b>	<b>17</b>
7.1	North American 120/240V Convertible 60Hz Models .....	17
7.2	Export 230V 50Hz Models .....	17
<b>8.0</b>	<b>Hot tub Fill Up Procedure.....</b>	<b>17</b>
<b>9.0</b>	<b>Hot tub Features.....</b>	<b>22</b>
<b>10.0</b>	<b>Control Panel.....</b>	<b>23</b>
10.1	Mode button.....	23
<b>11.0</b>	<b>Hot tub Maintenance.....</b>	<b>24</b>
11.1	Cleaning the filters .....	24
11.2	Surface Care.....	25
11.3	Maintaining the Hot Tub Cabinet .....	25
11.4	Pillow Care.....	25
11.5	Draining .....	26
11.6	Winterizing .....	26
11.7	Special Cold Weather Instructions.....	26
11.8	Maintaining the Cover.....	27
11.9	Restarting Your Hot Tub in Cold Weather .....	28
<b>12.0</b>	<b>Water Quality Maintenance .....</b>	<b>28</b>
12.1	pH Control.....	28
12.2	Sanitizing .....	29
12.3	Other Additives .....	29
<b>13.0</b>	<b>Troubleshooting.....</b>	<b>29</b>



## **1.0 Important Hot tub Owner Information**

Your hot tub is constructed to the highest standards and is capable of providing many years of trouble-free use. However, because heat retentive materials are utilized to insulate the hot tub for efficient operation, an uncovered hot tub surface and wall fittings directly exposed to sunlight and high temperatures for an extended period are subject to permanent damage or discoloration. Damage caused by exposing the hot tub to this abuse is not covered under warranty. We recommend that you always keep the hot tub full of water when it is exposed to direct sunlight and that you keep the insulating cover in place at all times when the hot tub is not in use. Read and carefully follow the requirements for your hot tub's support base found in the Section 4.0 titled, "Choosing a Location" (page 10).

## **2.0 FCC Notice**

This device complies with part 15 of the FCC Rules. Operation is subject to the following two conditions: (1) This device may not cause harmful interference, and (2) this device must accept any interference received, including interference that may cause undesired operation.



This equipment has been tested and found to comply with the limits for a Class B Digital Device, pursuant to Part 15 of the FCC Rules. These limits are designed to provide reasonable protection against harmful interference in a residential installation. This equipment generates, uses and can radiate radio frequency energy and, if not installed and used in accordance with the instructions, may cause harmful interference to radio communications. However, there is no guarantee that interference will not occur in a particular installation. If this equipment does cause harmful interference to radio or television reception, which can be determined by turning the equipment off and on, the user is encouraged to try to correct the interference by one or more of the following measures:

1. Rearrange or relocate the receiving antenna;
2. Increase the separation between the equipment and receiver;
3. Connect the equipment into an outlet on a circuit different from the circuit connected;
4. Consult the dealer or an experienced radio/TV technician for help. (Changes or modifications not expressly approved by the party responsible for FCC compliance could void the user's authority to operate this equipment.)

### 3.0 **IMPORTANT SAFETY INSTRUCTIONS FOR ALL HOT TUB OWNERS**

## **READ AND FOLLOW ALL INSTRUCTIONS CAREFULLY!**

This hot tub was manufactured to meet the standards and specifications outlined in the “Virginia Graeme Baker Pool and Spa Safety Act” (VGB Safety Act). When installing and using this hot tub, basic safety precautions should always be followed, including:

1.  **DANGER: RISK OF SEVERE INJURY OR DROWNING!**
  - Extreme caution must be exercised to prevent unauthorized access by children.
  - To avoid accidents, ensure that children do not use this hot tub unless supervised at all times. Adult supervision is a critical safety factor in preventing children from drowning.
  - Use the straps and clip tie downs to secure the hot tub cover when not in use. This will help discourage unsupervised children from entering the hot tub. Keep the hot tub cover secure in high-wind conditions.
  - There is no representation that the cover, clip tie-downs, or actual locks will prevent access to the hot tub.
  
2.  **DANGER: RISK OF SEVERE INJURY OR DROWNING!**
  - Keep hair, loose articles of clothing or hanging jewelry away from suction fittings, rotating jets or other moving components to avoid entrapment that could lead to drowning or severe injury.
  - Never use the hot tub unless all suction guards, filter, filter lid, or skimmer assembly are installed to prevent body and/or hair entrapment.
  - Never operate or use the hot tub if the filter, filter lid, or skimmer assembly are broken or any part of the skimmer assembly is missing. Please contact your dealer or nearest service center for service.
  - The suction fittings and suction covers in this hot tub are sized to match the specific water flow created by the pump(s). If it is necessary to replace the suction fittings, suction covers or pump(s), be sure that the flow rates are compatible and are in compliance with the VGB Safety Act.
  - Never replace a suction fitting or suction cover with one rated less than the flow rate marked on the original suction fitting. Using improper suction fittings or suction covers can create a body or hair suction entrapment hazard that may lead to drowning or severe injury.
  
3.  **DANGER: RISK OF SEVERE INJURY FROM ELECTRIC SHOCK OR DEATH FROM ELECTROCUTION!**
  - Install the hot tub at least 5 feet (1.5m), from all metal surfaces. As an alternative, a hot tub may be installed within 5 feet of metal surfaces if each metal surface is permanently connected (bonded)

by a minimum No. 8 AWG (8.4 mm<sup>2</sup>) solid copper conductor attached to the wire connector on the grounding lug, inside the equipment compartment on the equipment box.



- A grounding wire connector is provided on this unit to connect a minimum No. 8 AWG (8.4 mm<sup>2</sup>) solid copper conductor between this unit and any metal equipment, metal enclosures of electrical equipment, metal water pipe, or conduit within 5 feet (1.5m) of the unit.
- Never permit any electrical appliance, such as a light, telephone, radio, television, etc. within 5 feet (1.5m) of a hot tub unless such appliances are built-in by the manufacturer.
- Never bring any electrical appliances into or near the hot tub.
- Never operate any electrical appliances from inside the hot tub or when you are wet.
- The electrical supply for this product must include a suitably rated switch or circuit breaker to open all ungrounded supply conductors to comply with Section 422-20 of the National Electrical Code/USA, ANSI/NFPA 70. The disconnecting means must be readily accessible and visible to the hot tub occupant but installed at least 5 feet (1.5m), from the hot tub.
- The electrical circuit supplied for the hot tub must include a suitable ground fault circuit interrupter (GFCI) as required by NEC Article 680-42.

4.  **WARNING: RISK OF SEVERE INJURY OR DEATH!**



- Extreme caution must be exercised to prevent diving or jumping into the hot tub or slipping and falling, which could result in unconsciousness, drowning, or serious injury. Remember that wet surfaces can be very slippery.
- Never stand, walk or sit on the top railing of the hot tub.

5.  **WARNING: RISK OF HYPERTHERMIA (OVER-HEATING) CAUSING SEVERE INJURY, BURNS, WELTS OR DEATH!**

- Water temperature in excess of 104°F (40°C) may be injurious to your health.
- Refer to Section 3.2 Hyperthermia for specific causes and symptoms of this condition.
- The water in the hot tub should never exceed 104°F (40°C). Water temperatures between 100°F (38°C) and 104°F (40°C) are considered safe for a healthy adult.
- Lower water temperatures are recommended for young children (children are especially sensitive to hot water) and when hot tub use may exceed 10 minutes.
- The Consumer Products Safety Commission/USA has stated that the water temperature in a hot tub should not exceed 104°F (40°C).
- Always test the hot tub water temperature before entering the hot tub. The user should measure the water temperature with an accurate thermometer since the tolerance of water temperature-regulating devices may vary as much as +/- 5°F (2°C).

6.  **WARNING: RISK OF SEVERE INJURY OR DEATH!**
- Since excessive water temperatures have a high potential for causing fetal damage during the early months of pregnancy, if pregnant or possibly pregnant, consult your physician before using a hot tub.
  - Pregnant or possibly pregnant women should limit hot tub water temperatures to 100°F (38°C).
  - Persons suffering from obesity or a medical history of heart disease, low or high blood pressure, circulatory system problems, diabetes, infectious diseases or immune deficiency syndromes should consult a physician before using a hot tub.
  - If you experience breathing difficulties in association with using or operating your hot tub, discontinue use and consult your physician.
  - Persons using medication should consult a physician before using a hot tub since some medication may induce drowsiness, while other medication may affect heart rate, blood pressure, and circulation.
  - Persons suffering from any condition requiring medical treatment, the elderly, or infants should consult with a physician before using a hot tub.
  - The use of alcohol, drugs, or medication before or during hot tub use may lead to unconsciousness with the possibility of drowning.
7.  **WARNING: RISK OF SEVERE INJURY OR DEATH!**
- Prolonged immersion in a hot tub may be injurious to your health.
  - Observe a reasonable time limit when using the hot tub. Exposures at higher temperatures can cause high body temperature (over-heating). Symptoms may include dizziness, nausea, fainting, drowsiness, and reduced awareness. These effects could possibly result in drowning or serious injury.
  - Never use a hot tub immediately following strenuous exercise. Enter and exit the hot tub slowly. Wet surfaces can be slippery.
8.  **WARNING: TO DECREASE RISK OF INFECTION OR DISEASE!**
- To reduce the risk of contracting a waterborne illness (e.g. an infection, bacteria or virus) and/or respiratory ailments, maintain water chemistry within the parameters listed on the inside cover of this manual and consult with a licensed engineer regarding proper ventilation if installed indoors or in an enclosed area.
  - People with infectious diseases should not use a hot tub to avoid water contamination, which could result in spreading infections to others.
  - Always shower before and after using your hot tub. Maintain water chemistry in accordance with manufacturer's instructions. Failure to do so may result in contracting a waterborne illness (e.g. an infection, bacteria or virus).



9.  **WARNING:** In addition to maintenance of filters and water chemistry, proper ventilation is recommended to reduce the risk of contracting a waterborne illness (e.g. an infection, bacteria or virus) and/or respiratory ailments that could be present in the air or water. Consult a licensed architect or building contractor to determine your specific needs if installing your hot tub indoors.
10. **CAUTION: TO DECREASE RISK OF PRODUCT DAMAGE.**
- Maintain water chemistry in accordance with manufacturer's instructions.
  - Proper chemical maintenance of hot tub water is necessary to maintain safe water and prevent possible damage to hot tub components.
11.  **WARNING: RISK OF SEVERE INJURY OR DEATH!** The appliance is not intended for use by persons (including children) with reduced physical, sensory or mental capabilities, or lack of experience or knowledge, unless they have been given supervision or instruction concerning use of the appliance by a person responsible for their safety.
12. **NOTE:** This hot tub is not intended nor designed to be used in a commercial or public application. The hot tub buyer shall determine whether there are any code restrictions on the use or installation of this hot tub since local code requirements vary from one locality to another.

## Hot Tub Safety Literature

To ensure you have a safe and enjoyable hot tub experience, learn all you can about hot tub safety and emergency procedures.

The Pool & Hot Tub Alliance has a great source of safety literature.

- Go to <http://phta.org>
- Conduct your own search on the internet
- Write to the following address:  
Pool & Hot Tub Alliance  
2111 Eisenhower Avenue  
Alexandria VA 22314  
703.838.0083

FOR CALIFORNIA RESIDENTS ONLY  
NUR FÜR EINWOHNER KALIFORNIENS  
POUR LES RÉSIDENTS DE LA CALIFORNIE SEULEMENT  
PARA RESIDENTES DE CALIFORNIA ÚNICAMENTE



**WARNING:** Drilling, sawing, sanding or machining wood products can expose you to wood dust, a substance known to the State of California to cause cancer. Avoid inhaling wood dust or use a dust mask or other safeguards for personal protection. For more information go to [www.p65Warnings.ca.gov/wood](http://www.p65Warnings.ca.gov/wood)



**ACHTUNG:** Das Bohren, Sägen, Schleifen oder Zerspanen von Holzprodukten kann Stäube freisetzen. Diese Substanz gilt im US-Bundesstaat Kalifornien als krebserregend. Möglichst keinen Holzstaub einatmen bzw. eine Staubmaske oder anderweitige persönliche Schutzmaßnahmen einsetzen. Weitere Informationen finden Sie auf [www.P65Warnings.ca.gov/wood](http://www.P65Warnings.ca.gov/wood)



**AVERTISSEMENT:** Le forage, le sciage, le ponçage ou l'usage des produits du bois peuvent vous exposer à la poussière de bois, une substance connue dans l'État de Californie pour causer le cancer. Éviter d'inhaler la poussière de bois ou utiliser un masque antipoussières ou d'autres mesures de protection personnelle. Pour de plus amples renseignements, consulter le site [www.P65Warnings.ca.gov/wood](http://www.P65Warnings.ca.gov/wood)



**ADVERTENCIA:** Perforar, cortar, lijar o usar máquinas con productos de madera le puede exponer a polvo de madera, una sustancia reconocida por el Estado de California como causante de cáncer. Evite inhalar polvo de madera o utilice una máscara antipolvo u otros resguardos para protección personal. Para más información, visite [www.P65Warnings.ca.gov/wood](http://www.P65Warnings.ca.gov/wood)

6530-460 Rev A (12/18)

FOR CALIFORNIA RESIDENTS ONLY  
NUR FÜR EINWOHNER KALIFORNIENS  
POUR LES RÉSIDENTS DE LA CALIFORNIE SEULEMENT  
PARA RESIDENTES DE CALIFORNIA ÚNICAMENTE



**WARNING:** Cancer and Reproductive Harm  
[www.p65Warnings.ca.gov](http://www.p65Warnings.ca.gov)



**ACHTUNG:** Krebserregend und mit fortpflanzungsschädigender Wirkung-[www.p65Warnings.ca.gov](http://www.p65Warnings.ca.gov)



**AVERTISSEMENT:** Cancer et danger pour la reproduction  
[www.p65Warnings.ca.gov](http://www.p65Warnings.ca.gov)



**ADVERTENCIA:** Cáncer y daño reproductivo  
[www.p65Warnings.ca.gov](http://www.p65Warnings.ca.gov)

6530-464 Rev A (12/18)

### 3.1 Entrapment Risk

The Consumer Products Safety Commission/USA has reported that users of pools and spas have become entrapped (stuck) to drain and/or suction fittings causing death, drowning, or serious injury (see diagram below). This hot tub was manufactured to meet the standards and specifications outlined in the "Virginia Graeme Baker Pool and Spa Safety Act" (VGB Safety Act). Entrapment risk can be minimized if proper precautions are taken.





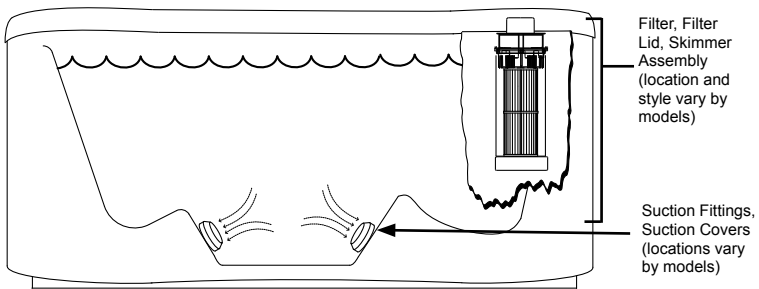

#### **DANGER: RISK OF PERSONAL INJURY OR DEATH!**

Never operate the hot tub if a suction fitting, suction cover, filter, filter lid or skimmer assembly are broken, damaged or missing.



**Note: Suction covers must be replaced every 7 years.**

-  **DANGER: RISK OF SEVERE INJURY OR DROWNING!**  
**Hair entrapment:** May occur if hair is entangled, knotted or snagged in a drain suction or skimmer assembly. This has been reported in persons who when submerge themselves underwater, allowing hair to come close and/or within the reach of the suction fittings, suction covers or skimmer assembly.
  - Keep hair away from suction fittings, suction covers, filter, filter lid or skimmer assembly.
  - Children are at risk for hair entrapment if swimming under water.
  - Never allow children to play or get near the suction fittings, suction covers, filter, filter lid or skimmer assembly.
-  **DANGER: RISK OF SEVERE INJURY OR DROWNING!**  
**Limb entrapment:** May occur when a limb becomes entrapped, inserted or sucked into a suction or outlet opening.
  - Always keep suction fittings, suction covers, filter, filter lid or skimmer assembly in place when operating to avoid limb entrapment.
  - Never allow children to play or get near the suction fittings, suction covers, filter, filter lid or skimmer assembly.

3.  **DANGER: RISK OF SEVERE INJURY OR DROWNING!**  
**Body entrapment:** May occur when part of the torso becomes entrapped, inserted or sucked into a suction or outlet opening.
  - Never allow children to play or get near the suction fittings, suction covers, filter, filter lid or skimmer assembly.
  
4.  **DANGER: RISK OF SEVERE INJURY OR DROWNING!**  
**Evisceration (disembowelment) entrapment:** May occur when the buttocks becomes entrapped, inserted or sucked into a suction or outlet opening.
  - Never sit on suction fittings, suction covers, filter, filter lid or skimmer assembly.
  - Never allow children to play or get near the suction fittings, suction covers, filter, filter lid or skimmer assembly.
  
5.  **DANGER: RISK OF SEVERE INJURY OR DROWNING!**  
**Mechanical entrapment:** May occur when jewelry, swimsuit, or hair accessories become entangled, knotted or snagged in a drain suction or skimmer assembly.
  - Never allow your jewelry, swimsuit, or hair accessories to come close to the suction fittings, suction covers or skimmer assembly.
  - Never allow children to play or get near the suction fittings, suction covers, filter, filter lid or skimmer assembly.

### 3.2 Hyperthermia

Prolonged immersion in hot water may induce hyperthermia (overheating). The use of alcohol or drugs can greatly increase the risk of fatal hyperthermia in spas. A description of the causes, symptoms, and effects of hyperthermia are as follows:

Hyperthermia occurs when the internal temperature of the body reaches a level several degrees above the normal body temperature of 98.6°F (37°C). The symptoms of hyperthermia include drowsiness, lethargy (fatigue), and an increase in the internal temperature of the body (feeling of being too hot). The effects of hyperthermia include:

- Unawareness of impending hazard;
- Failure to perceive heat;
- Failure to recognize the need to exit hot tub;
- Physical inability to exit hot tub;
- Fetal damage in pregnant women; and
- Unconsciousness and danger of drowning.

### 3.3 Warning Signs

Each hot tub has been provided with a Warning Sign and an Important Notice label. This label outlines safety precautions. This sign should be permanently placed in a location that is visible to the hot tub user.



### 3.4 IMPORTANT SAFETY INSTRUCTIONS

When using this electrical equipment, basic safety precautions should always be followed, including the following:

1. **READ AND FOLLOW ALL INSTRUCTIONS.**
2. A green colored terminal or a terminal marked G, Gr, Ground, Grounding or the ⊕ symbol\* is located inside the supply terminal box or compartment. To reduce the risk of electric shock, this terminal must be connected to the grounding means provided in the electric supply service panel with a continuous copper wire equivalent in size to the circuit conductors that supply this equipment. \*IEC Publication 417, Symbol 5019.
3. At least two lugs marked “Bonding Lugs” are provided on the external surface or on the inside of the supply terminal box/ compartment. To reduce the risk of electric shock, connect the local common bonding grid in the area of the hot tub to these terminals with an insulated or bare copper conductor not smaller than No. 6 AWG (10 mm<sup>2</sup>).
4. All field-installed metal components such as rails, ladders, drains or other similar hardware within 10 feet (3m) of the hot tub shall be bonded to the equipment grounding buss with copper conductors not smaller than No. 6 AWG (10 mm<sup>2</sup>).
5. **SAVE THESE INSTRUCTIONS.**

## 4.0 Choosing a Location

**IMPORTANT:** Because of the combined weight of the hot tub, water and users, it is extremely important that the base upon which the hot tub rests be smooth, flat, level and capable of uniformly supporting this weight, without shifting or settling, for the entire time the hot tub is in place. Visit [www.d1spas.com](http://www.d1spas.com) for weight information. If the hot tub is placed on a surface, which does not meet these requirements, damage to the skirt and/or the hot tub shell may result. Damage caused by improper support is not covered under warranty. It is the responsibility of the hot tub owner to assure the integrity of the support at all times. We recommend a poured, reinforced concrete slab with a minimum thickness of 4 inches (10 cm). Wood decking is also acceptable provided it is constructed so that it meets the requirements outlined above.



**WARNING:** For spas that are to rest on balconies, roofs or other platforms not specifically tied into main structural support, consult a professional Structural Engineer with experience in this type of application.



**WARNING:** Proper drainage is required. The installation must not allow the spa equipment bay to become flooded or wetted (by external water). It is your responsibility, and the responsibility of any installation contractor you hire, to make sure that all applicable codes and/or local construction requirements are met. If in doubt, refer to the building authority responsible for approving the proposed installation site.

The hot tub must be installed in such a manner as to provide drainage away from it. Placing the spa in a depression without provisions for proper drainage could allow rain, overflow, leaks from spa plumbing, and other casual water to flood the equipment and create a wet condition in which it would sit in. For spas which will be installed below grade or recessed into a floor or deck, install so as to permit access to the equipment, either from above or below, for servicing. Make certain that there are no obstructions, which would prevent removal of all side cabinet side panels and access to the jet components, especially on the side with the equipment bay.



**CAUTION:** If the hot tub is indoors or located in an enclosed area, proper ventilation should be discussed with an Engineer or authority competent enough to understand the necessary provisions needed to vent moist or heated air and air associated with chemical odors outdoors. **When the hot tub is in use considerable amounts of moisture will escape potentially causing mold and mildew. This can cause health risk.** Over time, this can damage certain surfaces, surroundings, and equipment.

#### 4.1 Outdoor Location

In selecting the ideal outdoor location for your hot tub, we suggest that you take into consideration:

- The proximity to changing area and shelter (especially in colder weather).
- The pathway to and from your hot tub (this should be free of debris so that dirt and leaves are not easily tracked into the hot tub).
- The closeness to trees and shrubbery (remember that leaves and birds could create extra work in keeping the hot tub clean).
- A sheltered environment (less wind and weather exposure can result in lowered operation and maintenance costs).
- The overall enhancement of your environment. It is preferable not to place the hot tub under an unguttered roof overhang since run-off water will shorten the life expectancy of the hot tub cover.
- For spas that are to rest on balconies, roofs or other platforms not specifically tied into main structural support, consult a professional Structural Engineer with experience in this type of application.
- In the unlikely event that you should ever need to access or gain entry to any portion of the hot tub for servicing, it is highly recommended that you plan your outdoor installation to provide full access to the entire hot tub. Please take this into consideration when placing the hot tub in a deck or enclosed by a surrounding.
- Consider locating your hot tub away from any reflective surface or glass to prevent any damage to the synthetic skirt.
- Do not shim the hot tub. To ensure proper support the hot tub must sit flat on the intended foundation.

#### 4.2 Indoor Location

For indoor installations many factors need to be considered before installing a hot tub indoors.



**WARNING:** In addition to maintenance of filters and water chemistry, proper ventilation is recommended to reduce the risk of contracting a waterborne illness (e.g. an infection, bacteria or virus) and/or respiratory ailments that could be present in the air or water. Consult a licensed architect or building contractor to determine your specific needs if installing your hot tub indoors.

- **Proper Foundation: Consult a Structural Engineer when considering a foundation that will adequately support the hot tub the entire time it is in place.** Proper support is critical especially if the hot tub is to rest on a second story or higher. For spas that are to rest on balconies, roofs or other platforms not specifically tied into the main structural support, you should consult a professional Structural Engineer with experience in this type of application.

## @Home Collection

- **Proper Drainage: It is extremely important to have in place measures to sufficiently handle excessive water spillage.** Be sure the flooring in which the hot tub rests on has adequate drainage and can handle the entire contents of the hot tub. Be sure to make provisions for ceilings and other structures that may be below the spas installation. Areas around your hot tub can become wet or moist so all flooring and subsequent furniture, walls and adjacent structures should be able to withstand or resist water and moisture.
- **Proper Ventilation: Proper ventilation should be discussed with an Engineer or authority competent enough to understand the necessary provisions needed to vent moist or heated air and air associated with chemical odors outdoors.** When the hot tub is in use considerable amounts of moisture will escape, potentially causing mold and mildew over time, which can damage certain surfaces and/or surroundings.
- **Sufficient Access:** In the unlikely event that you should ever need to access or gain entry to any portion of the hot tub for servicing, it is highly recommended that you plan your indoor installation to provide full access to the entire hot tub.
- **Warranty:** Damage caused by not following these guidelines or any improper installation not in accordance to local codes or authorities is not covered under the spas warranty. Please consult your local state or city building ordinances.
- **Do not shim the hot tub.** To ensure proper support the hot tub must sit flat on the intended foundation.

### 5.0 General Electrical Safety Instructions

This hot tub must be installed properly to ensure dependable usage. Please contact your local dealer or local building department should you have any questions regarding your installation.



Proper grounding is extremely important. D1® spas are equipped with a current collector system. A pressure wire connector is provided on the surface of the control box to permit connection of a bonding wire between this point and any ground metal equipment, metal water pipe or conduit within 5 feet (1.5m) of the hot tub, or copper clad grounding rod buried within 5 feet (1.5m) of the hot tub. Bonding wire must be at least No. 8 AWG (8.4 mm<sup>2</sup>) solid copper wire. This is a most important safety assurance feature. Before installing your hot tub, check with your local building department to ensure installation conforms to local building codes.

#### 120/240 Volt Convertible Models

A spa connected to a 120 VAC electrical service must be located close enough to a grounded, grounding-type electrical outlet so that the included 10 foot (3m) power cord can be plugged directly into it. **DO NOT USE AN EXTENSION CORD** as this could cause damage to the spa's equipment due to insufficient voltage. The power supplied to this spa must be a dedicated circuit with no other appliances or lights sharing the power provided by the circuit.



## A. ELECTRICAL CONNECTION

**IMPORTANT:** About your GFCI Circuit Breaker — The GFCI (Ground Fault Circuit Interrupter — also called a “circuit breaker”) is an electrical safety switch that automatically shuts off power to the spa in case of an electrical malfunction. There must be a GFCI installed according to your local building codes in an electrical power box near your spa.

The GFCI should be OFF before you fill your spa. Manually turn off power to the spa any time by using the GFCI. Just push the switch to the OFF position. After turning off the GFCI, make sure the control panel display window is blank, so you know the power is off. When you are ready to turn the power back on, reset the GFCI by returning the switch to the ON position. Do not use your spa unless you understand the operation of the GFCI.

## 6.0 Electrical Installation Instructions

**IMPORTANT NOTICE:** The electrical wiring of this hot tub must meet the requirements of the National Electrical Code/USA (NEC) and any applicable state or local codes. The electrical circuit must be installed by a qualified electrician and approved by a local building/ electrical inspection authority.

### 1. Convertible 120/240V Models Only:

-  **DANGER: TO DECREASE THE RISK OF SHOCK, PRODUCT DAMAGE OR ELECTRICAL FIRE.**  
120V “Plug-in” Operation: This spa must operate on the supplied 10 foot (3m) 120V GFCI cord at its original length or must be hard-wired for longer runs. **NEVER USE AN EXTENSION CORD FOR ANY REASON!**
  - Always test the GFCI before each use. Press the test button on the cord to make sure it is functioning. After testing, press the reset button to return to normal operation.
  - Replace damaged cord immediately.
  - Do not bury cord.
  - Connect to a grounded, grounding type receptacle only.
  - Convertible 120/240V Heater Operation: The included 120V GFCI cord must be removed for 240V heater operation. This spa must be hard-wired. Supplying power to either configuration above which is not in accordance with these instructions will void both the independent testing agency listing and the manufacturer’s warranty.
2. The power supplied to this hot tub must be a dedicated circuit with no other appliances or lights sharing the power provided by the circuit.

## @Home Collection

3. To determine the current, voltage and wire size required, refer to Section 7.0 “Power Requirements” (page 17) for your specific hot tub model.
  - Wire size must be appropriate per NEC and/or local codes.
  - We recommend type THHN wire. All wiring must be copper to ensure proper connections. **Do not use aluminum wire.**
  - When using wire larger than #6 (10 mm<sup>2</sup>), add a junction box near the hot tub and reduce to short lengths of #6 (10 mm<sup>2</sup>) wire to connect to the hot tub.
4. The electrical supply for this product must include a suitably rated switch or circuit breaker to open all ungrounded supply conductors to comply with Section 422-20 of the National Electrical Code/ USA, ANSI/NFPA 70. The disconnecting means must be readily accessible to the hot tub’s occupant but installed at least 5 feet (1.5m) from hot tub water.
5. The electrical supply for this product must include a suitably rated isolating switch and circuit breaker to comply with local electrical regulations. This RCD/GFCI circuit breaker must be installed at the power supply in the house electrical box.
6. The electrical circuit supplied for the hot tub must include a suitable ground fault circuit interrupter (GFCI) as required by NEC Article 680-42/USA.
7. The electrical circuit supplied for the hot tub must include a suitable residual-current device (RCD) as required by local codes and regulations.
8. For Europe, the hot tub should be supplied through a residual current device (RCD) with a rated tripping current not exceeding 30mA (IEC 60335-2-60).
9. For Germany, the hot tub should be supplied through a residual current device (RCD) with a rated tripping current not exceeding 10mA (IEC 60335-2-60).
10. To gain access to the hot tub’s power terminal block, you will need to remove the center cabinet panel by removing the panel screws, Figure 6.0.
- 11a. Once you remove the panel screws, grab the sides of the panel and gently pull the cabinet forward and then up to remove. Place the panel in a safe location to prevent it from being damaged.
- 11b. For models with the optional insulation panels: After removing the panel, gently remove the insulation blanket from the center section and fold it back, Figure 6.0a. Remove the insulation panel and place it in a safe location, Figure 6.0b.
12. Then remove the door screws for the access door on the control box, Figure 6.0c.
13. Now feed the electrical cable through to the terminal pipe ending at the control box, Figures 6.0d - 6.0e.
14. Connect wires to the terminal block (Figures 6.0f - 6.0g). **ALL WIRES MUST BE SECURELY CONNECTED** or equipment damage could result.

15. Re-install control box door and screws, insulation panel (if equipped), insulation blanket (if equipped), and reinstall the cabinet side panels.

**IMPORTANT NOTICE:** Make sure to install the drain hose bib, that is packaged in the warranty pack, on to the hot tub. Securely screw in and close the drain valve and drain cap.

Figure 6.0

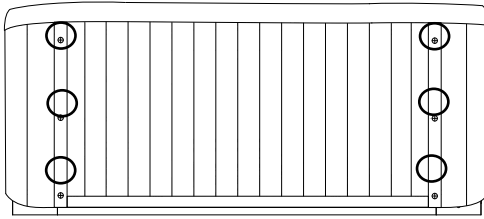

Figure 6.0a

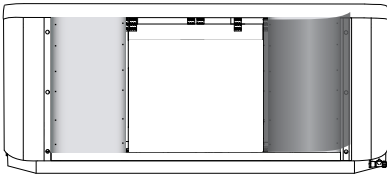

Figure 6.0c

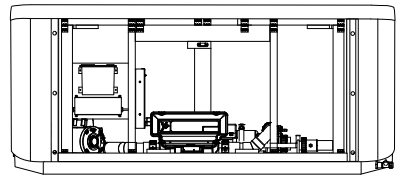

Figure 6.0b

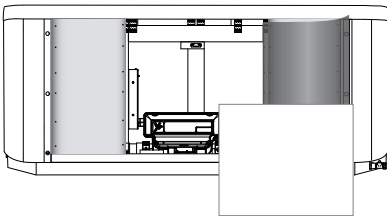

Figure 6.0d

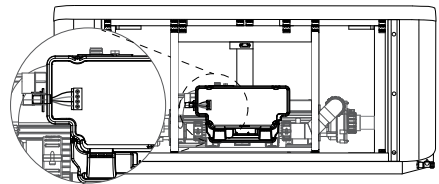
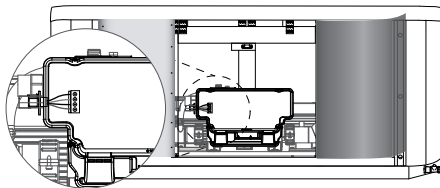

Figure 6.0e



## DOMESTIC

Figure 6.0f

### 120V/240V 60Hz Convertible Terminal Wiring

120V Convertible Connection

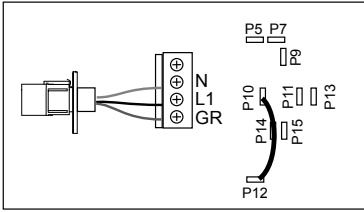

Brown wire connects to:  
P10 and P12

240V Convertible Connection

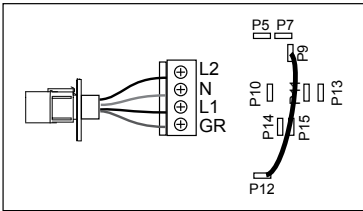

Brown wire connects to:  
P9 and P12

## EXPORT

Figure 6.0g

### 230 50Hz Export Terminal Wiring

1-Phase Connection

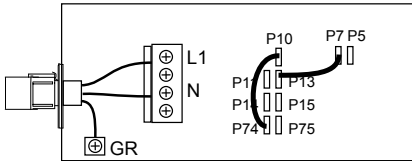

PJ1 wire connects to:  
P7 and P13

PJ2 wire connects to:  
P10 and P74

2-Phase Connection

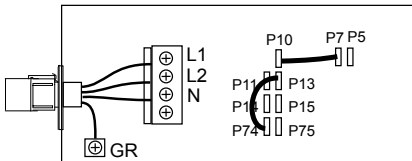

PJ1 wire connects to:  
P7 and P10

PJ2 wire connects to:  
P13 and P74

3-Phase Connection with Single Neutral

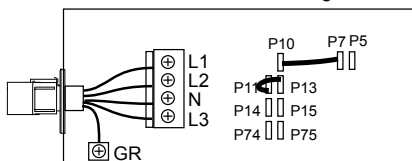

PJ1 wire connects to:  
P7 and P10

PJ2 wire connects to:  
P11 and P13

## 7.0 Power Requirements

### 7.1 North American 120/240V Convertible 60Hz Models

Model	Power	Branch Circuit	Circuit Protection	Wire Gauge
@Home Collection	120V	GFCI Cord	15A	GFCI cord
	240V	3 wires + Ground	30A	#6 awg
	240V	3 wires + Ground	40A	#6 awg

### 7.2 Export 230V 50Hz Models

Model	Power	Circuit Protection
@Home Collection	230V	1 x 32A
		2 x 16A
		3 x 16A

## 8.0 Hot tub Fill Up Procedure

For best results, read each step in its entirety before proceeding with this procedure. Make sure all drains are closed before you begin.

**IMPORTANT NOTICE:** Make sure to install the drain hose bib, that is packaged in the warranty pack, on to the hot tub. Securely screw in and close the drain valve and drain cap.

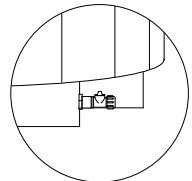

Figure 8.0a

### Pre-installation tip

Ask your dealer to check on the following items during installation. If your dealer/electrician is not setting up your tub, you can easily do these two tasks yourself by removing the front panel of equipment compartment using a Phillips screwdriver.

- Check that the pump unions are hand tight to prevent possible leakage.
- Remove the shipping bolts located on the front of the pump mount if they have not yet been removed.

### 1. Prepare The Hot tub For Filling

- Clear all debris from the hot tub. (Although the hot tub shell has been polished at the factory, you may want to treat it with a specially formulated hot tub cleaner.) Consult your authorized Dimension One dealer for additional information prior to filling hot tub.
- Remove the filters as illustrated in Section 11.1.

**CAUTION:** Do not leave the spa shell exposed to the sun during the filling process. Leaving it exposed could result in surface damage and not covered under the warranty.

2. **Fill Hot tub**

- Place the end of your garden hose into the empty skimming filter fitting. Remove the air bleeder cap to allow the air to escape as the hot tub fills, page 22.

**CAUTION: TO DECREASE BUILD UP ON COMPONENTS AND MINIMIZE ACRYLIC DAMAGE.** Never fill with water from a water softener. If your water is extremely “hard,” it is preferable to fill half-way with hard water and the rest of the way with softened water. Water that is too soft can be corrosive to metal components.

-  **WARNING: TO DECREASE RISK OF INFECTION OR DISEASE.**

Fill hot tub with clean tap water from garden hose, to reduce risk of contracting a waterborne illness (e.g. an infection, bacteria or virus) and/or respiratory ailments. Fill the spa until the water level is about 6" below the top of the spa. (DO NOT OVERFILL!).

**IMPORTANT:** Always fill your hot tub through both filter fittings after draining. Failure to do so may cause air to be trapped in the pumps, preventing them from circulating water.

3. **Turn On Power**

Turn on power to hot tub at the home's circuit breaker. The filter pumps will turn on for one minute each to blow out the plumbing lines. Then the heater and circulation pump will automatically activate. Activate Jets Pump 1 to prime the pump, page 23. Let it run for about 10-15 seconds. Repeat this process with all the pumps. Once, all the pumps are primed, cleared of airlocks, and there are no flow errors, reinstall the filter cartridge and close the air bleeder cap.

4. **Add Start-Up Chemicals**

Turn on the jet pumps when adding chemicals in order to circulate the chemicals thoroughly. Add the hot tub water chemicals as recommended by your authorized hot tub dealer. See Section titled “Water Quality Maintenance” for general guidance.



**WARNING: RISK OF POISONING OR DEATH.**

Never leave chemicals opened and accessible to anyone. Use chemicals according to the vendor's instructions. Always store chemicals in a safe and/or locked location. Keep away from and out of reach of children.

**5. Establish A Stable Sanitizer Reading**

Establish a stable sanitizer reading of no less than 3.0-4.0 ppm free chlorine or 2.0-4.0 ppm bromine. To ensure healthy water conditions, always maintain a constant sanitizer reading within the levels recommended by the Pool & Hot Tub Alliance. If sanitizer levels cannot be stabilized, perform the decontamination procedure steps 8-14 on the following page.

**6. Set Hot tub To Heat**

To warm hot tub water to a comfortable temperature, follow these steps:



- The display on the control panel displays the actual temperature of the hot tub water. Tap up or down button to increase or decrease the water temperature in 1 degree increments.

**7. Place Cover On Hot tub**

- Keeping the insulating cover in place anytime the hot tub is not in use will reduce the time required for heating, thereby minimizing operating costs.
- The time required for initial heat-up will vary depending on the starting water temperature.
- Align the cover on the spa and use the included hardware to attached the cover locks to spa cabinet.



**DANGER: RISK OF PERSONAL INJURY.**

Check water temperature carefully before entering hot tub! Excessive water temperature can cause burns, welts and body temperature to rise, hyperthermia (over-heating).

**Decontamination Procedure**

Steps 8-14 below are only required when sanitizer levels are unstable after performing Hot Tub Fill Up Procedures steps 1-5. Disregard steps 8-14 if sanitizer levels remain stable after performing steps 1-5 above.

**Note:** The “Decontamination Procedure” should also be used after the hot tub has been “Winterized” (page 26) or has been sitting without power for an extended period.

8. Add 2.5 ounces of sodium dichlor for every 100 gallons of water. Refer to the table for approximate water fill volume by model.



**CAUTION: RISK OF PERSONAL INJURY OR HOT TUB DAMAGE!**

Never add chlorine tablets (trichlor) or acid to your hot tub for any reason! These chemicals may damage components within your hot tub, burn or irritate your skin, create a rash, and void the manufacturer warranty for your hot tub.

## @Home Collection

### Water Fill Volume by Model

Model	Average Fill Volume*	Sodium Dichlor
Breeze .....	315 Gal (1,192 L) .....	7.9 oz
Cove .....	260 Gal ( 984 L) .....	6.5 oz
Dream .....	300 Gal (1,136 L) .....	7.5 oz
Journey .....	240 Gal ( 910 L) .....	6.0 oz
Latitude .....	385 Gal (1,457 L) .....	9.6 oz
Meridian .....	375 Gal (1,420 L) .....	9.4 oz
Serenade .....	240 Gal ( 910 L) .....	6.0 oz
Sojourn .....	340 Gal (1,287 L) .....	8.5 oz
Wayfarer .....	275 Gal (1,041 L) .....	7.0 oz

\*Use average fill volume for chemical maintenance

9. Leave hot tub cover open during this step to allow excessive chemical vapors to exit hot tub, protecting pillows and plastic knobs from chemical attack. If hot tub is indoors, open doors and windows for proper ventilation. Turn on all hot tub jet pumps for 1 hour and place all massage selector knob(s) in their center “combo” position.

**Note:** You will need to activate the jet pumps every 30 minutes since these functions have an automatic 30-minute time-out that turns them off.



#### **WARNING: RISK OF PERSONAL INJURY!**

- To decrease the risk of injury, drowning or entrapment, never leave your hot tub unattended for any reason while the cover is open and accessible, especially to small children and animals!
- Use the hot tub straps and clip tie downs to secure the cover when not in use. This will help to discourage unsupervised children from entering the hot tub and keep the hot tub cover secure in high wind conditions. There is no representation that the cover, clip tie downs, or actual locks will prevent access to the hot tub.
- Precautions should be taken to minimize your exposure to chemical vapors (that could cause lung, brain, or skin damage).

10. Turn off power to the hot tub at the circuit breaker, then drain tub as outlined in Section 11.5.
11. Refill hot tub with clean tap water from garden hose. Fill the spa until the water level is about 6” below the top of the spa. (DO NOT OVERFILL!).



**CAUTION: TO DECREASE BUILD UP ON COMPONENTS AND MINIMIZE ACRYLIC DAMAGE.**

Never fill with water from a water softener. If your water is extremely "hard," it is preferable to fill halfway with hard water and the rest of the way with softened water. Water that is too soft can be corrosive to metal components.

12. Consult your authorized Dimension One Spas dealer for chemical recommendations, then add chemicals to hot tub water to achieve a constant sanitizer reading within the levels recommended.
13. Turn on jet pumps when adding chemicals to ensure proper mixing and leave your hot tub cover open until the sanitizer level becomes stable to protect pillows and plastic knobs from chemical attack.



**WARNING: RISK OF PERSONAL INJURY.**

- To decrease the risk of injury, entrapment or drowning, never leave your hot tub unattended for any reason while the cover is open and accessible to small children and animals!
- To decrease the possibility of contracting a waterborne illness (e.g. an infection, bacteria or virus) and/or respiratory ailments, maintain water chemistry within step 6 parameters. If you or other bathers experience such a condition, discontinue use and seek medical attention.

14. Establish a sanitizer reading no less than 3.0-4.0 ppm free chlorine or 2.0-4.0 ppm bromine, then allow the hot tub to set undisturbed for 8 hours. Retest water after 8 hours to determine if sanitizer levels are stable. If sanitizer levels are stable, your hot tub is ready for use. To ensure healthy water conditions, always maintain a constant sanitizer reading within the levels recommended on the inside cover of this manual. If sanitizer levels are not stable at this time, it will be necessary to repeat this procedure in its entirety until stable sanitizer readings are achieved.

**IMPORTANT:** Follow the water chemistry parameters as defined by the Pool & Hot Tub Alliance.

15. After adequate sanitizer levels are achieved, close all hot tub air controls to maximize heat retention when hot tub is not in use.

9.0 Hot tub Features

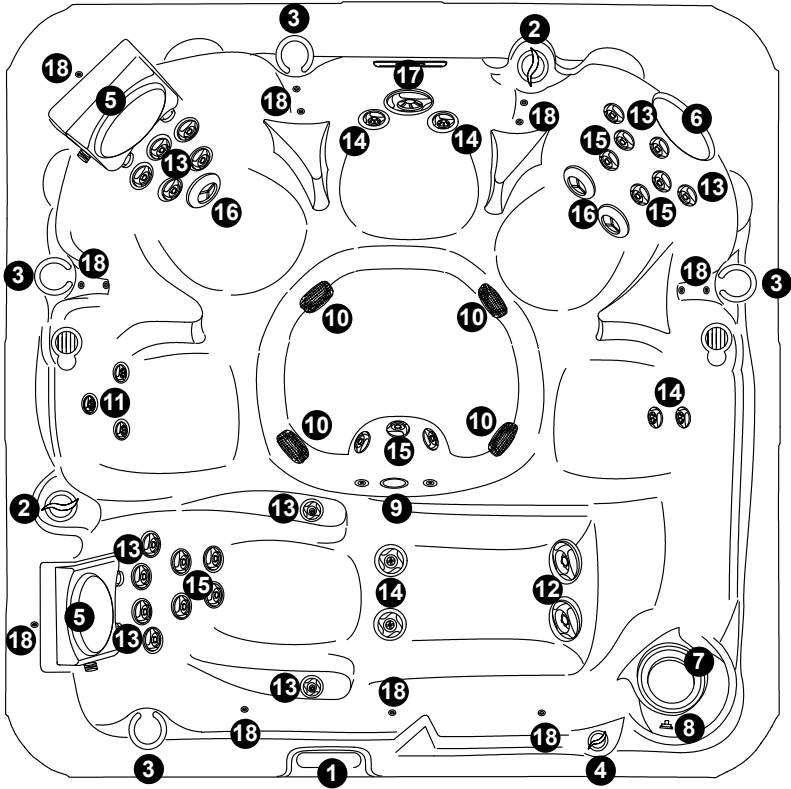

Latitude Model Shown (features vary by model)

- |                                    |   |
|------------------------------------|---|
| 1. Control Panel                   | 11. Cluster Storm Rifled Jets (2 ea.)       |
| 2. Massage Selectors (2 ea.)       | 12. Poly Storm Rifled Jets (2 ea.)          |
| 3. Cupholders (4 ea.)              | 13. Mini Storm Rotator Jets (14 ea.)        |
| 4. Fountain Control Valve          | 14. Mini Storm Rifled Jets (6 ea.)          |
| 5. Jet Therapy Pillows™<br>(2 ea.) | 15. Mini Storm Directional Jets<br>(11 ea.) |
| 6. Standard Pillow                 | 16. Power Storm Twister Jets<br>(3 ea.)     |
| 7. Filter/Skimmer                  | 17. Power Storm Rifled Jet (1 ea.)          |
| 8. Air Relief Valve                | 18. Bullet Lights (13 ea.)                  |
| 9. Main Light                      |   |
| 10. Suction Covers (4 ea.)         |   |

Hot tub features and operations are subject to change without notice

## 10.0 Control Panel

Press any button to activate the keypad. After 2 minutes without activity, the keypad will go dark.

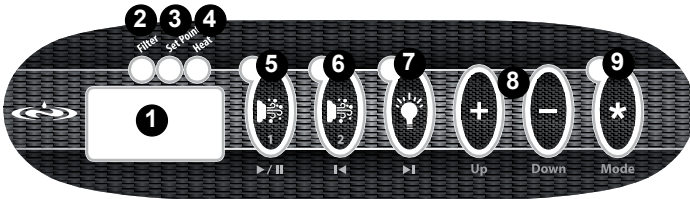

The pictured control is the two-pump version, models that have one pump will only have one “Jets” button.

1. Display Window: Shows the current status of the hot tub.
2. Filter Indicator Light: Glows when a filter cycle is in progress.
3. Set Indicator Light: Glows when the temperature displayed is the desired temperature, not the actual water temperature.
4. Heat Indicator Light: Glows when the heater is on.
5. Jets Button 1: Push once for low speed, twice for high speed. Push a third time to turn off.
6. Jets Button 2: Push once to turn on, twice to turn off.
7. Light Button: Turns light on and off. To lock or unlock a color, turn light off for three seconds, then on again.
8. Up and Down Buttons : Change desired water temperature.
9. Mode Button : Opens the options menus.

### 10.1 Mode button

#### A. Options Menu

To open the options menu, hold the Mode button for three seconds. Once in the menu, use the Up and Down buttons to adjust each option. Push the Mode button to move to the next option. If you don't push anything for ten seconds, the menu will quit and save your changes automatically.

- Filter Cycle Length: Choose from 60, 90, 120, 150 or 180 minutes.
- Filter Cycles Per Day: Choose from one, two, three or four cycles.
- Temperature Units: Choose from Fahrenheit (°F) or Celsius (°C).

**Note:** A built-in timer will automatically shut the pump off after 30 minutes (60 minutes on some models), unless it is turned off manually. A new 30-minute cycle begins for each pump when its JETS button is pushed. Use this function to cause the spa to filter immediately after use— just push the Jets button once when you get out.

## 11.0 Hot tub Maintenance

Proper and regular maintenance of your hot tub will help it retain its beauty and performance. Your authorized Dimension One Spas dealer can supply you with all the information, supplies, and accessory products you will need to accomplish this.



### **DANGER: RISK OF SEVERE INJURY OR DROWNING BY ENTRAPMENT!**

- Keep hair, loose articles of clothing or hanging jewelry away from suction fittings, rotating jets or other moving components to avoid entrapment that could lead to drowning or severe injury.
- Never use the hot tub unless all suction guards, filter, filter lid, or skimmer assembly are installed to prevent body and/or hair entrapment.
- Never operate or use the hot tub if the filter, filter lid, or skimmer assembly are broken or any part of the skimmer assembly is missing. Please contact your dealer or nearest service center for service.
- The suction fittings and suction covers in this hot tub are sized to match the specific water flow created by the pump(s). If it is necessary to replace the suction fittings, suction covers or pump(s), be sure that the flow rates are compatible and are in compliance with the VGB Safety Act, page 7.
- Never replace a suction fitting or suction cover with one rated less than the flow rate marked on the original suction fitting. Using improper suction fittings or suction covers can create a body or hair suction entrapment hazard that may lead to drowning or severe injury.
- Owners must alert all hot tub users to the potential risk of Hair, Limb, Body, Evisceration (disembowelment), and Mechanical Entrapment, page 7.

### 11.1 Cleaning the filters

**Turn power OFF!** To ensure optimum performance, it is necessary to remove and clean the skimmer basket once a week and filter cartridge once a month or sooner, depending on usage and water quality.

- To access the filter under the skimmer basket, lift the center float off the skimmer assembly until fully extended. Turn counterclockwise until the flats of the basket line up with the securing tabs. Pull the assembly straight up to remove.
- Using a garden hose with a high-pressure nozzle to rinse debris from the filter pleats, begin at the top and work your way downward. Continue, one section at a time, until you have rinsed all of the filter's pleats.
- Every two months, soak your filter in filter cleaning solution. Be sure to rinse your filter thoroughly before putting it back in your spa.
- Once a year, replace your filter.

- Every other cleaning, soak the filter in filter-cleaning solution and rinse thoroughly. Reinstall the filter by reversing the steps for removal, replace the skimmer basket or lid and turn the power back on. Run the pump(s) for a few minutes at high speed before leaving the system to its normal heating and filtration cycles.

### Vision Cartridge

The Vision Cartridge offers D1 hot tub users a natural and effective way to reduce the use of chemically-based water sanitation systems. Used in combination with D1 ozone systems, the Vision Cartridge uses silver catalyst technology that kills 99.96% of impurities on contact. One Vision Cartridge lasts up to 6 months and can reduce the need for extra chemicals by 60% for cleaner, healthier and softer water.

## 11.2 Surface Care

**IMPORTANT:** Do not use alcohol, ammonia, bleach or any citrus based cleaners on any of your hot tub surfaces. Do not use “409” type cleaners or other caustic solutions as they may damage the hot tub shell surface and void the warranty.

**IMPORTANT:** Protect the hot tub surface from the sun and the cold! Keep the hot tub covered when empty of water. Sunlight and extreme cold can damage the surface and cause it to peel or blister.

Use a hot tub cleaner and a soft rag to clean the inside of your hot tub. Be sure to thoroughly rinse the shell. After cleaning, you will want to restore your hot tub shell’s original luster by using Dimension One Spas’ Poli-Gloss.

## 11.3 Maintaining the Hot Tub Cabinet

The hot tub cabinet requires little or no maintenance of any kind. To clean, wipe cabinet with a clean towel and mild detergent soap solution.



**CAUTION:** Never spray cabinet with a high-pressure garden hose for any reason since this action may induce an electrical short in the hot tub’s electrical equipment.

## 11.4 Pillow Care

Remove and clean the headrest pillows, as needed, with soapy water using a cloth or soft-bristle brush. Always remove the pillows when adding chemical shock treatment to the spa water. The pillows can be returned to the spa when the sanitizer reading is stable as recommended.

## 11.5 Draining

**IMPORTANT:** Keep the hot tub covered when empty of water. Sunlight and extreme cold can damage the surface and cause it to peel or blister.

1. **Turn power OFF!**
2. Locate the hose bib, at the bottom of the hot tub, Figure 11.5a. Make sure that the valve is in the OFF position.
3. Unscrew the cap from the spa drain, Figure 11.5b.
4. Attach one end of your garden hose to the drain valve, Figure 11.5c. Place the other end in an area safe for water runoff.
5. Turn the hose bib switch to the open position to release the water, Figure 11.5d.
6. Once the hot tub is drained, turn the switch back to the closed position, remove the hose and reinstall the cap.

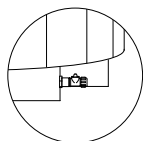

Figure 11.5a

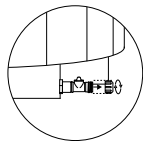

Figure 11.5b

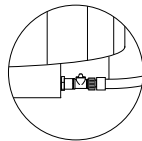

Figure 11.5c

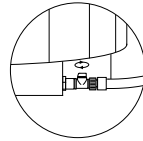

Figure 11.5d

## 11.6 Winterizing

All D1 spas are designed for year-round use. Your hot tub has an automatic freeze protection mode to circulate water during freezing weather, assuming the system has electrical power and the proper water level. However, if freezing weather prohibits normal use, an authorized service provider should winterize your hot tub. Draining the unit will not prevent freeze damage, as small amounts of water in the plumbing can expand and damage the system. Winterizing the unit is specifically not covered by the manufacturers' warranty, so you should contact a professional to both winterize and restart your hot tub if necessary. Freeze damage caused by winterizing your system is specifically not covered by your warranty.

## 11.7 Special Cold Weather Instructions

The system has a "Smart Winter" freeze protection mode to circulate water during freezing weather, assuming the system has electrical power and the proper water level. It will automatically activate the pump(s) to circulate water. This is a normal hot tub function. No corrective action is necessary. This feature protects the spa from freezing.

However, if there freezing conditions present and shutting down the spa for the winter is unavoidable, or where conditions may get too cold for the spa's "Smart Winter" mode to prevent freezing, the spa should be Winterized by a professional Dimension One dealer or authorized service representative.

## 11.8 Maintaining the Cover

UltraLast™ and UltraLast™ Extreme Covers: Dimension One Spas® is committed to maintaining the quality of your hot tub. That's why our patented UltraLast™ and UltraLast™ Extreme Covers have superior durability. They are UV, water, mold and mildew resistant to protect your tub against environmental exposure.

Vinyl Covers: To maintain a “nearly original” appearance on your vinyl cover, it is recommended that a protectant with a high SPF (sun protection factor) is applied at least once a month if exposed to direct sunlight. You will also want to clean and condition your cover monthly or as needed based on exposure. For more information, consult your dealer.

### A. To clean and condition the encasement (cover skin):

1. Use a garden hose to remove any debris.
2. Using a large sponge or soft bristle brush, use diluted or mild soap to gently scrub the top.
3. Rinse and clean and do not allow soap to dry on the cover. Do not use soap on the underside of the cover.
4. Please check with your Dimension One Spas dealer for recommended cover care and conditioning products. Use non-petroleum based conditioners to keep the vinyl supple.
5. Do not use any solvents, abrasive cleaners or strong detergents. Do not use products that contain silicone or alcohol.

### B. Additional Care and Maintenance Instructions:

1. Debris can accumulate on the spa cover. Removal of snow or other debris will help to avoid breakage of the foam cores.
2. Be sure to lock the cover straps to secure the cover from unwanted or accidental entry.
3. Do not place heavy objects on the vinyl.
4. Do not walk, sit or stand on the cover.
5. Do not drag or use the flaps/skirt or the cover lock straps to remove the cover.
6. Use only recommended cover lift systems.
7. Use only chemicals and cleaners recommended by Dimension One Spas.
8. Remember to keep spa covered when not in use.
9. Do not expose your spa to the sun for extended periods of time as UV rays can damage the interior surface.
10. Use caution when removing cover. Before removing cover, assure all locks have been released to avoid lock breakage and/or cover strap damage.

### 11.9 Restarting Your Hot Tub in Cold Weather

If you want to start up your hot tub after it has sat empty for a time in freezing temperatures, be aware that the water remaining in certain sections of the piping may still be frozen. This situation will block water flow preventing the hot tub from operating properly and possibly damaging the equipment. We recommend you consult your dealer for guidance before attempting to restart your hot tub under these conditions.

### 12.0 Water Quality Maintenance

To decrease the risk of contracting a waterborne illness (e.g. an infection, bacteria or virus) and/or respiratory ailments, maintain water quality within specified limits. This will enhance your enjoyment and prolong the life of the hot tub's equipment. Doing so requires regular attention because the water chemistry involved is a balance of several factors. Procrastination regarding water maintenance will result in poor and potentially unhealthful conditions for soaking and even damage to your hot tub investment. For specific guidance, on maintaining water quality, consult your authorized dealer who can recommend the appropriate chemical products.



**WARNING: FAILURE TO MAINTAIN WATER QUALITY WILL:**

- Increase risk of contracting a waterborne illness (e.g. an infection bacteria or virus) and/or respiratory ailments.
- Damage the equipment, components and hot tub shell, which are not covered under the hot tub's warranty.

**CAUTION:** Never store hot tub chemicals inside the hot tub's equipment bay. The equipment bay may reach elevated temperatures, this is where high voltage electronic devices are located. This area is not intended for storage of any kind.

### 12.1 pH Control

pH is a measure of relative acidity or alkalinity of water and is measured on a scale of 0 to 14. The midpoint of 7 is said to be neutral, above which is alkaline and below which is acidic. In hot tub water, it is very important to maintain a slightly alkaline condition of 7.4 to 7.6. Problems become proportionately severe the further outside of this range the water gets. A low pH will be corrosive to metals in the hot tub equipment. A high pH will cause minerals to deposit on the interior surface (scaling). In addition, the ability of the sanitation agents to keep the hot tub clean is severely affected as the pH moves beyond the ideal range. That is why almost all hot tub water test kits contain a measure for pH as well as sanitizer.



## 12.2 Sanitizing

To destroy bacteria and organic compounds in the hot tub water, a sanitizer must be used regularly. Chlorine and bromine are the two most popular sanitizers used to date. Many other additives are available for your hot tub. Some are necessary to compensate for out-of-balance water; some aid in cosmetic water treatment and others simply alter the feel or smell of the water. When adding hot tub shock (chlorine or non-chlorine) or pH balancing chemicals activate the jet pump(s) and leave the hot tub cover open for a minimum of 20 minutes. By doing this you will allow excessive chemical vapors to exit the hot tub, protecting pillows and plastic knobs from chemical attack.



**WARNING: RISK OF PERSONAL INJURY, DROWNING OR ENTRAPMENT!** Never leave your hot tub unattended for any reason while the cover is open and accessible, especially to small children and animals!

**CAUTION: RISK OF PERSONAL INJURY OR HOT TUB DAMAGE!** Never add chlorine tablets (trichlor) or acid to your hot tub for any reason! These chemicals may damage components within your hot tub, burn or irritate your skin, create a rash and void the manufacturer warranty for your hot tub.

## 12.3 Other Additives

Many other additives are available for your hot tub. Some are necessary to compensate for out-of-balance water, some aid in cosmetic water treatment and others simply alter the feel or smell of the water. For specific guidance, on maintaining water quality, consult your authorized dealer who can recommend the appropriate chemical products.

## 13.0 Troubleshooting

For help troubleshooting common occurrences, contact your local dealer.

**Always insist on genuine Dimension One Spas replacement parts.**

If you need further assistance, you can email our service department at:

**USA:** [service@d1spas.com](mailto:service@d1spas.com)

**International:** [Service-Europe@d1spas.com](mailto:Service-Europe@d1spas.com)

### Error Messages

1. Temperature over 112°F (44°C)

**WARNING! DO NOT ENTER SPA!** Your hot tub has overheated. Open the cover and allow the water to cool below 110°F (43°F). Once the water has cooled, reset your GFCI to restart your spa.

Spa water may be very hot. Do not touch or enter the water and contact your Authorized D1 dealer immediately for service.

## @Home Collection

2. HL or OH error

**WARNING! DO NOT ENTER SPA!**

Spa water may be very hot. Do not touch or enter the water and contact your Authorized D1 dealer immediately for service.

3. Wrong Temperature

**WARNING! DO NOT ENTER SPA!** The actual water temperature is unknown.

Spa water may be very hot. Do not touch or enter the water and contact your Authorized D1 dealer immediately for service.





DIMENSION ONE SPAS®

100

●●●●●●●● @HOME COLLECTION

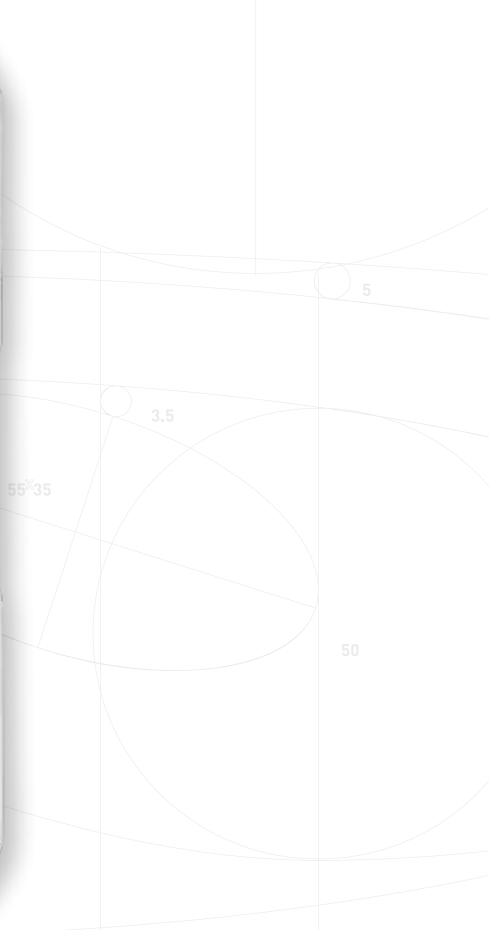

[www.d1spas.com](http://www.d1spas.com)

© 2020 Dimension One Spas.  
All trademarks and registered trademarks  
are the property of their respective owners.

PN: 6530-437H Rev. A (10/20)